

# PEARL®

## 5" PNEUMATIC REAR EXHAUST WET POLISHER

MODEL PA2322WR  
OWNER'S/OPERATOR'S MANUAL



### **SERIAL NUMBER -**

*You should record the Serial Number of your polisher on this Owner's/Operator's Manual*

**Caution!** *Read Safety and General Instructions carefully before using the tool for the first time.*

**⚠ WARNING:** This product can potentially expose you to chemicals that are known to the State of California to cause cancer and birth defects or other reproductive harm. For more information, go to: [www.P65Warnings.ca.gov](http://www.P65Warnings.ca.gov)

**REV. 2**

Made in Japan

**PEARL ABRASIVE CO. PA2322WR POLISHER**

# **i. TABLE OF CONTENTS**

	PAGE
ii. GENERAL SAFETY RULES AND PRECAUTIONS .....	3
iii. SILICA DUST WARNING .....	7
iv. FEATURES .....	7
v. SPECIFICATIONS .....	7
vi. UNPACKING, ASSEMBLY & OPERATION PROCEDURES .....	8
vii. SPECIFIC CAUTION FOR AIR SUPPLY .....	11
viii. ABOUT AIR PRESSURE AND VOLUME .....	11
ix. ABOUT SILENCE .....	11
x. MAINTENANCE & TROUBLESHOOTING .....	12
xi. REPLACEMENT PARTS LIST .....	14
xii. HOW TO ORDER PARTS .....	15
xiii. CUSTOMER SERVICE .....	15

## ii. GENERAL SAFETY RULES AND PRECAUTIONS

 **WARNING!** *Read all instructions. As with all machinery there are certain hazards involved with operation and use of the machine. The following basic safety precautions should be followed at all times to reduce the risk of fire, electric shock and serious personal injury to you or others. Keep these important operating instructions with this product.*



1. Know your power tool - read owner's/operator's manual carefully. Learn its applications and limitations as well as the specific potential hazards unique to this tool.
2. Keep guards in place - and in working order.
3. Ground all tools - if tools are equipped with three prong plug, it should be plugged into a three-hole electrical receptacle. If an adapter is used to accommodate a two-prong receptacle, the adapter lug must be attached to a known ground. Never remove the third prong.
4. Remove wrenches - Form a habit of checking to see that adjusting wrenches are removed from tool before turning it "on".
5. Keep work area clean. Cluttered areas and benches invite accidents.
6. Do not use in dangerous environment. Do not use power tools in damp or wet locations, or expose them to rain. Keep work area well lighted. Do not use tool in the presence of flammable liquids or gasses.
7. Keep children and visitors away. All children and visitors should be kept at a safe distance from work area.
8. Make workshop childproof with padlocks, master switches or by removing starter keys.
9. Do not force tool. It will do the job better and be safer at the rate for which it was designed.
10. Use right tool. Do not force tool or attachment to do a job for which it was not designed.
11. Wear proper apparel. Do not wear loose clothing, gloves, neckties, rings, bracelets or other jewelry that may get caught in moving parts. Non-slip footwear is recommended. Wear protective hair covering to contain long hair.
12. **Always use safety glasses.** Wear safety glasses (must comply with ANSI Z87.1) at all times. Everyday eyeglasses only have impact resistant lenses; they are not safety glasses. Use face or dust mask if cutting operation is dusty, and ear protectors (plugs or muffs) during extended periods of operation.
13. Do not overreach. Keep proper footing and balance at all times.
14. Maintain tools in top condition. Keep tools sharp and clean for best and safest performance. Follow instructions for lubricating and changing accessories. Inspect tool cords periodically and if damaged, have repaired by authorized service facility.
15. Disconnect tools. When not in use, before servicing, and when changing accessories, such as blades, bits, cutters.
16. Avoid accidental starting. Make sure switch is in "off" position before plugging in power cord.
17. Use recommended accessories only. Consult the owner's manual for recommended accessories. The use of improper accessories may cause risk of injury to persons.
18. Never stand on tool. Serious **injury** could occur if the tool is tipped or if the cutting tool is accidentally contacted.
19. Check Damaged Parts. Before further use of the tool, a guard or other part that is damaged should be carefully checked to ensure that it will operate properly and perform its intended function. Check for alignment of moving parts, binding of moving parts, breakage of parts, mounting, and any other conditions that may affect its operation. A guard or part that is damaged should be properly repaired or replaced.
20. Never leave tool running unattended. Turn power "off". Do not leave tool until it comes to a complete stop.
21. Extension cords. Make sure your extension cord is in good condition. When using an extension cord, be sure to use one heavy enough to carry the current your product will draw. An undersized cord will cause a drop in line voltage resulting in loss of power and overheating. If in doubt, use the next heavier gage. The smaller the gage numbers the heavier the cord.

## GENERAL SAFETY RULES AND PRECAUTIONS

22. Do not abuse cord. Never carry tool by cord or pull it to disconnect from receptacle, Keep cord from heat, oil, and sharp edges.
23. Guard against electric shock. Prevent body contact with grounded surfaces. For example, pipes, radiators, ranges and refrigerator enclosures.
24. Outdoor use extension cords. When tool is used outdoors, use only extension cords intended for use outdoors and so marked.
25. Stay alert. Watch what you are doing. Use common sense. Do not operate tool when you are tired.
26. Drugs, alcohol, medication. Do not operate tool while under the influence of drugs, alcohol or any medication.
27. Store idle tool. When not in use, tool should be stored in a dry and locked place, out of reach of children.
28. Do not use the tool for a purpose other than designated by the manual.
29. Please check both air hose and water hose not to mix-up connecting.
30. Keep work area clean and well lit. Cluttered or dark areas invited accidents.
31. Always wear personal protective equipment such as safety goggles, hearing protectors and dust mask or respiratory protective equipment (PPE).
32. Follow ANSI Z87.1 or local/national standards for eye-wear and other personal protective equipment requirements. Everyday eyeglasses are not safety glasses.
33. Exposure to certain chemicals in dust generated from workpiece and/or abrasive materials can result in lung damage and other physical injury. Your risk of exposure varies, depending on how often you do this type of work. To reduce your exposure to dust, work in a well-ventilated area and work with approved safety equipment designed to filter out microscopic particles.
34. Dress properly. Do not wear loose clothing or jewelry as they can be caught in moving parts. Contain long hair with a cap or a hair cover.
35. When operating an air tool outside, always wear gloves, safety shoes (preferably non-skid) and hard hat.
36. Use sound insulation walls if required by your local provisions and regulations.
37. Stay alert, be careful with what you are doing when operating an air tool. Do not use tool while tired or under the influence of drugs, alcohol or medication.
38. Do not overwork and have a rest before you get too tired.
39. Always check rotation direction before use.
40. Never place your hand or face near the rotating accessory.
42. Do not operate the tool continually at full throttle without a work load on the tool.
43. Do not dismantle or modify the tool.
44. Do not direct the tool towards bystanders and/or animals. Fragments of workpiece or of a broken accessory may fly away and cause injury. Keep bystanders out of work area.
45. Do not abuse the hose. Never use the air hose for carrying. The tool can start suddenly and may cause injury. Keep the air hose away from sharp edges.
46. Do not use damaged air hose. Damaged air hose increase the risk of accident.
47. Never work near inflammable liquid or in a highly explosive area.
48. Make sure that the tool is off before connecting to the air compressor.
49. Always disconnect the tool from air supply before removing any accessory or maintenance work.
50. Do not force tool. Use the correct tool for your application. The correct tool will do the job better and safer.
51. If any physical hand/wrist discomfort is experienced, stop work promptly and seek medical attention. Hand, wrist and arm injury may result from repetitive work, motion and overexposure to vibration. Take frequent rest and limit daily time of use.
52. Handle the tool with care. Dropping the tool on a ground, crashing it into objects may cause the tool to deform and crack.
53. Use only an air compressor. Use of high pressure gas other than an air such as an oxygen and acetylene will increase the risk of explosion.
54. Pneumatic tool's exhaust air contains oil and contaminated moisture. Make sure it is not directed towards you or anyone within the work area.
55. Do not overreach. Keep proper footing and balance at all times.
56. When working at height, make sure that nobody is underneath, and ensure also that the tool is kept on a stable platform.
57. Always inspect wires and pipes inside the workpiece. Carefully use the tool so that the rotating part will not contact them. The rotating part contacting electric wires and gas pipes while operating the tool will increase the risk of electric shock and gas leak.
58. When polishing, pay attention to dust and sand on the surface of polishing pad or polishing buff, so that they do not leave scratches on the workpiece.

59. Do not press the tool too hard against the workpiece. It is not only inefficient but also may cause damages to the tool.
60. Never lay the tool until the accessory has come to a complete stop.
61. Do not abuse the tool. Do not throw, drop or shock the tool.
62. Do not carry the tool by the air hose, and do not pull it to disconnect at the same time.
63. Do not cover or block an exhaust. Blocked exhaust obstructs the tool from working properly. Also, do not direct exhaust air towards bystanders and/or animals.
64. Dress properly.
65. Do not wear loose fitting clothing or jewelry that could be caught in moving parts.
66. Immediately stop operating the tool if you feel the tool is not working correctly. If damaged, have the tool serviced.
67. Stay alert, be careful while operating this tool. Do not use tool while tired or under the influence of drugs, alcohol, or medications.
68. Keep children and bystanders at a safe distance from work area.
69. Do not use tooling that could be hazardous if it becomes wet. (i.e.grinding stones)
70. Never place hand or face near a moving accessory.
71. Use only genuine Pearl replacement parts for repairs.
72. Always turn it off and disconnect from air compressor before installing and removing accessories, before adjusting or when making repairs.
73. Never use damaged accessories.
74. Wear personal protective equipment such as safety glasses that conforms to ANSI/ISEA Z87.1, and ear protection that conforms to ANSI/ISEA S12.6.
75. Always securely clamp and support work piece.
76. Do not use damaged air hose.
77. Always wear proper respiratory protection. A dust mask or similar dust respirator should be used.
78. Keep tools clean and lubricated.
79. Always disconnect tool when not in use, especially when changing tools.
80. Inspect before using, check alignment of moving parts and breakage or improper mounting.
81. Use the Pearl PA2322WR for wet polishing only.
82. Only use a Backing pad rated for 5000 RPM or higher.



### **SPECIFIC WARNINGS FOR PA2322WR**

1. Only qualified/trained operators should use this tool.
2. Use clamps etc. to secure and support the workpiece.
3. Use accessories made for pneumatic tools.
4. Hold the tool firmly, especially when starting.
5. When using polishing pads with Velcro, always ensure that the pad is fixed centrally to the backing pad.

### **CAUTION**

1. Do not abuse the tool. Do not throw, drop or shock the tool.
2. Do not carry the tool by the air hose, and at the same time, do not pull it to disconnect.
3. Do not cover or block an exhaust. Blocked exhaust prevents the tool from working properly. Also, never direct exhaust air towards bystanders and/or animals.
4. Dress properly
5. Do not wear loose fitting clothing or jewelry that could be caught in moving parts.
6. Do not cover or block exhaust. Blocked exhaust prevents the tool from working properly.
7. Immediately stop operating the tool if you feel the tool is not working correctly. If damaged have the tool serviced.
8. Stay alert, be careful while operating this tool. Do not use tool while tired or under the influence of drugs, alcohol, or medications.

### **SPECIFIC CAUTION FOR MAINTENANCE**

1. Immediately stop operating the tool whenever you feel that the tool is not working properly. If damaged, have the tool serviced.
2. Use appropriate pressure. Excessively high pressure will increase the number of revolutions or strokes causing potential failure and accidental injury.
3. Use only identical replacement parts when servicing.
4. Do not store unused accessories and tools in an area where temperature changes a lot and/or under the direct sunlight. Store them in a dry area and out of reach of children.
5. Inspect tool before use; check if parts and accessories are free from damage.
6. Do not use damaged accessory.
7. Never use solvents or other harsh chemicals to clean the non-metallic parts of the tool.

## GENERAL SAFETY RULES AND PRECAUTIONS

8. Before use each day place 2-3 drop of pneumatic tool oil in the air inlet of the tool. Run tool for 2-3 seconds to allow moving parts to become lubricated. Lubricating the tool before and during work is not needed. Excessive oil will turn into a tar-like substance inside the tool, causing the vanes to stick in the rotor and slow the tool down.
9. At the end of the shift disconnect air and water line and hang the tool upside down to allow any water to drain from the tool.
10. Clean coupler fittings on air hoses so that a motor will not ingest powder dust and sand. Also, use clean water from a tap.
11. If you notice deformation of a backing pad in any way, discontinue its use and replace the backing pad.
12. Do not submerge the tool in water. This will expose the inner moving parts to moisture that will shorten the life expectancy.
13. Do not leave accessories attached to the threads of the spindle. This can result in damage to the spindle or accessory. Excessive force to the spindle trying to remove corroded accessories could damage the gears and bearings.
14. If you notice any abnormal noise or vibration when operating the product, immediately discontinue its use. Inspect and replace any damaged parts. If abnormal noise or smell persist, return the machine for service or repair.
15. For further operational and handling information or for replacement of parts and components, please contact the agent from whom you purchased the tool.



**WARNING! CALIFORNIA PROPOSITION 65: Sawing and drilling generates dust. Excessive airborne particles may cause irritation to eyes, skin and respiratory tract. To avoid breathing impairment always employ dust controls and protection suitable to the material being saw or drilled in accordance with OSHA (29 CFR Part 1910.1). Diamond blades improperly used are dangerous. Comply with ANSI Safety Code B7.1 and OSHA covering speed, safety guards, flanges, mounting procedures, general operating rules, handling, storage and general machine condition.**



KEEP GUARD IN PLACE



DIAMOND BLADE



BLADE CUTTING DEPTH



ELECTRIC SWITCH OFF



ELECTRIC SWITCH ON



ELECTRICAL HAZARD



REMOVE TOOLS



PAY EXTREME ATTENTION



REPAIRS TO BE DONE



MACHINE HAZARD



FLAMMABLE



READ INSTRUCTIONS CAREFULLY



WARNING



FRAGILE



KEEP DRY



DO NOT STEP ON



WEAR HEARING PROTECTION



WEAR EYE PROTECTION



WEAR BREATHING PROTECTION



WEAR HARD HAT



WEAR PROTECTIVE CLOTHING



WEAR SAFETY SHOES

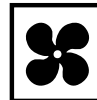

WELL VENTILATED



NO NON-WORKING PERSONNEL

### iii. SILICA DUST WARNING

Grinding/cutting/drilling of tile, masonry, concrete, metal and other materials with silica in their composition may give off dust or mists containing crystalline silica. Silica is a basic component of sand, quartz, brick clay, granite and numerous other minerals and rocks. Repeated and/or substantial inhalation of airborne crystalline silica can cause serious or fatal respiratory diseases, including silicosis. In addition, California and some other authorities have listed respirable crystalline silica as a substance known to cause cancer. When cutting such materials, always follow respiratory precautions.

Use appropriate NIOSH-approved respiratory protection where dust hazard may occur. Paper masks or surgical masks without NIOSH approval number are not recommended because they do little to protect the worker. For more information about respirator programs, including what respirators have received NIOSH approval as safe and effective, please visit the NIOSH website at <http://www.cdc.gov/niosh/topics/respirators>

Observe OSHA regulations for respirator use (29 C.F.R.§1910.134).

Visit <http://www.osha.gov> for more information.

### iv. FEATURES

- Professional design for continuous production applications
- Aircraft aluminum casting
- Watertight sealed bearings provide long life and smooth operation
- Air and water controls are conveniently located and easy to use
- Rear air vent exhaust protector
- 15' water hose and 5' air hose
- Handle and wrenches included
- 90-day limited warranty

### v. SPECIFICATIONS

<b>PA2322WR Polisher</b>	Air Pressure Max	90 PSI
	RPM	5,500 (free speed)
	Shaft Thread	5/8"-11
	Air Inlet	1/4" NPT
	Length	10-1/4 in.
	Air Consumption	16 CFM
	Air Compressor Required	5 hp min.
	Water Connection	3/4" GHT
	Max. Disc Size	5"
	Weight	2.7 lbs.

## vi. UNPACKING, ASSEMBLY & OPERATION PROCEDURES

### UNPACKING

Your PA2322WR Wet Stone Polisher has been shipped from the factory thoroughly inspected. Only minimal assembly is required. Check the content for the following items before discarding any packaging:



PA2322WR



Handle



Air, Water & Exhaust Hoses



Water Hose Joint  
Hose Nipple



Spanner Wrench



Hose Fastener



Tool Oil



Owner's Manual

*Proceed to the following section to complete assembly of the polisher.*



## ASSEMBLY



1. Insert the Hose Nipple into the Water Hose.

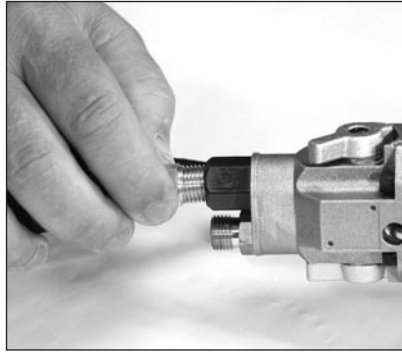

2. Thread the air hose to the polisher air hose fitting.



3. Tighten the air hose nut.

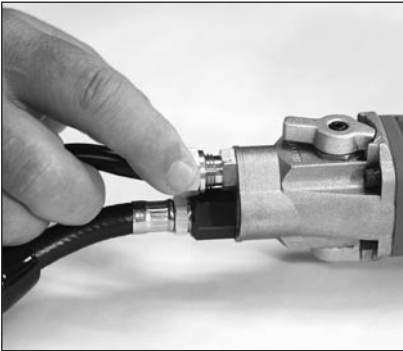

4. Thread the water hose to the water hose fitting.

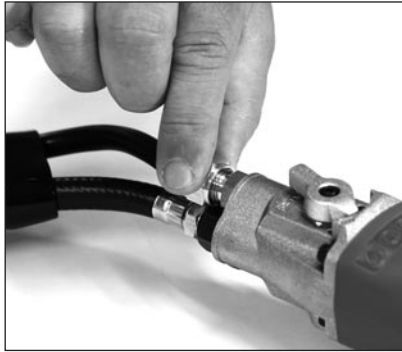

5. Tighten the water hose nut.

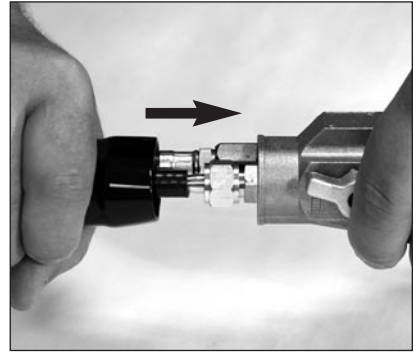

6. Slide the exhaust hose over the water and air hoses.



7. Use the fastener to secure exhaust hose to polisher.

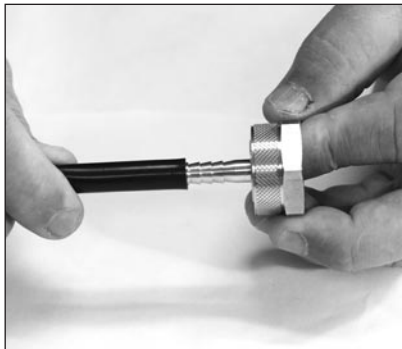

8. Attach water hose joint to end of water hose.



9. Attach the handle and tighten.

## OPERATION PROCEDURES



1. Screw on backer plate.



2. Place polishing pad on backer plate.

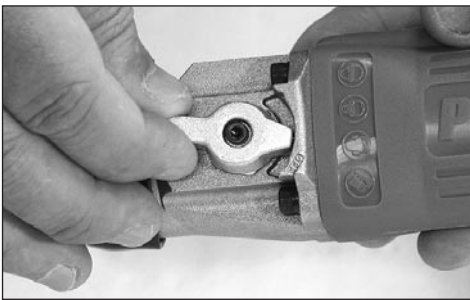

3. Turn the water on to desired water volume.



4. Turn the air on to the desired rotation speed. Begin polishing.

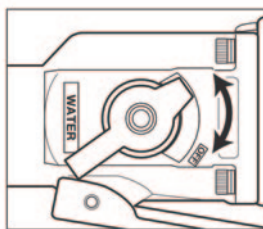

Clockwise  
(right) turn  
**Water volume  
low/Off**

Counterclockwise  
(left) turn  
**Water volume high**

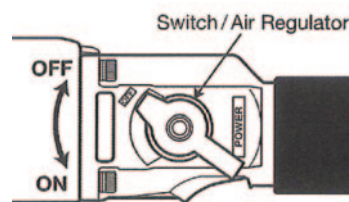

Clockwise  
(right) turn  
**Low speed**

Counterclockwise  
(left) turn  
**High speed**

## vii. SPECIFIC CAUTION FOR AIR SUPPLY

1. Use a clean lubricated air supply that will give a measured pressure at the tool of 90 PSI/6 bar (0.6 MPa)
2. Air pressure for this tool **MUST NOT** exceed 90 PSI/6 bar (0.6 MPa); excessively high air pressure will increase the number of revolutions causing not only potential failure or breakage but could also lead to an unexpected accident or injury.
3. Equip the air compressor with a replaceable filter that can be easily cleaned.
4. Use safety shuttle valves so air flow can be stopped in case of a line break.
5. Use anti-whip devices across hose couplings to prevent hose from whipping in the event of hose failure or coupling disconnect.
6. Regularly clean the tool's air vents.
7. Connect the tool to the air supply as shown below.

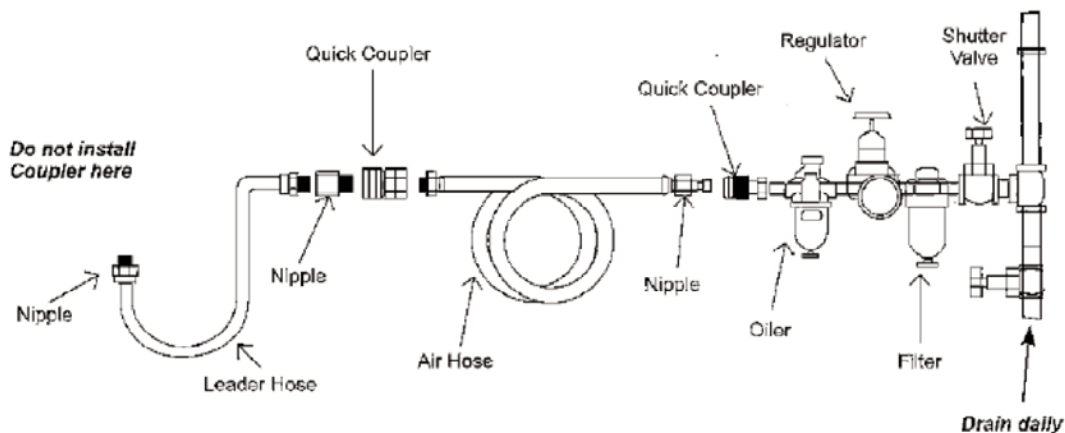

## viii. ABOUT AIR PRESSURE AND VOLUME

1. The manufacturer specification on the tool is 5,000 RPM at 80-90 PSI. Pressure over 90 PSI exceeds the max speed rating for the rotor bearings that could potentially cause them to overheat and lock.
2. The air consumption of this polisher is very important. This tool requires 16 CFM (cubic feet per minute) for the tool to run at a constant speed. Each additional tool that is attached to an air compressor will require 16 CFM.

## ix. ABOUT SILENCE

To comply with OSHA code 1926.52 Noise exposure Standard, this polisher comes fitted with an internal silencer. When operated within factory specifications (80-90 PSI @ 16 CFM) the silencer brings the noise to less than 84 db. The silencer also provides back pressure to help assure that you are getting a constant RPM level.

## X. MAINTENANCE & TROUBLESHOOTING

### MAINTENANCE

Use 3-4 drops of spindle/machine oil in the air intake valve. The polisher must be oiled daily.



Grease gears as needed using a multi-purpose EP lithium grease or moly EP lithium grease. DO NOT use oil.

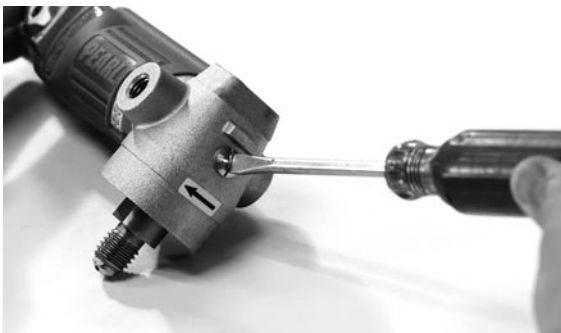

- During operation, lubricate the air tool oil, if necessary. Lubricate a few drops of oil from the air inlet, and operate it for a few seconds so as for oil to diffusing into the whole housing.
- After operations, air-blow moisture attached to the machine body, and cleanly wipe off the dirty moisture. And lubricate a few drops of air tool oil from the air inlet. After a few seconds operations, store the tool in dry place.
- Keep the hose attached port clean so as to prevent dust to enter from the air inlet into the housing.

### WARNING!

- Make sure to install the handle and the pad so as not to loosen.
- Use the pad and polishing materials specific and adequate to this machine.
- In order to replace or install the pad and polishing material and other attachments, be sure to remove the air hose.
- Be sure to use the dry and clean compressed air.
- Don't use the tool in pressure exceeding air pressure 0.63Mpa.
- The air tool is precious machine. Don't throw, drop or give a strong shock thereto, which will cause damage to the machine.
- Avoid using the tool beyond the usage, and forced operations exceeding the performance.
- Its irregular noise or vibration should occur, or tool performance is deteriorated, immediately stop the operation. Check if any failure such as a breakage is found in attachments or the machine. If troubles are not resolved, though the attachment has been replaced or lubricated, contact to the purchase shop.

## TROUBLESHOOTING

### Note:

Do not submerge the polisher in water. Water and moisture will harm and rust the inner parts of the polisher.

Remove backer pads after each use and use a drop of oil on the spindle to prevent rust.

Excessive downward force on polisher will result in premature failure of gears and bearing.

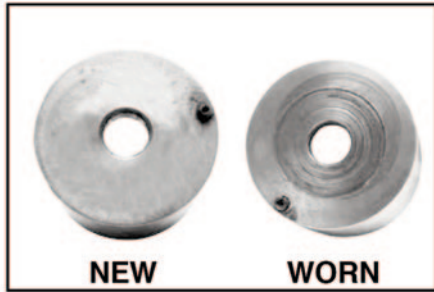

Wear in front plate due to worn bearings



Wear in the bevel gear is due to using the polisher as a grinder and applying heavy pressure and hammering the tool onto the material.



Wear in pinion gear is due to using polisher as a grinder, hammering the tool onto the material.

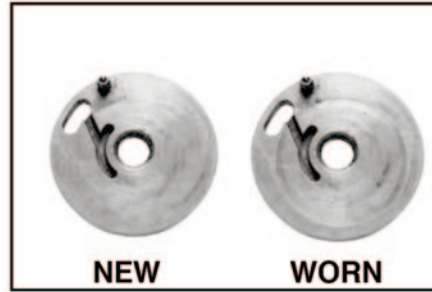

Wear in rear plate due to worn bearings.

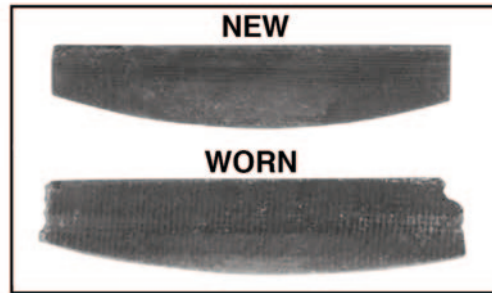

A broken rotor blade is due to excessive downward pressure on the polisher and lack of regular oiling.

### IN CASE OF NO OPERATION AND WRONG OPERATION

1. Check if the sufficient air is supplied with adequate pressure.
2. Check if the air hose is connected in place, and air leak found or not.
3. Check if the air regulator lever is opened.
4. Considering oil level down, try idling operation in lubrication.

### WATER WON'T COME OUT

1. Check if sufficient water is supplied from the faucet.
2. Check if water leaks or clogs, while the water hose is connected in place.
3. Check if the water adjusting lever is opened.
4. Check if the water injecting nozzle is clogged with dust.

# xi. REPLACEMENT PARTS LIST

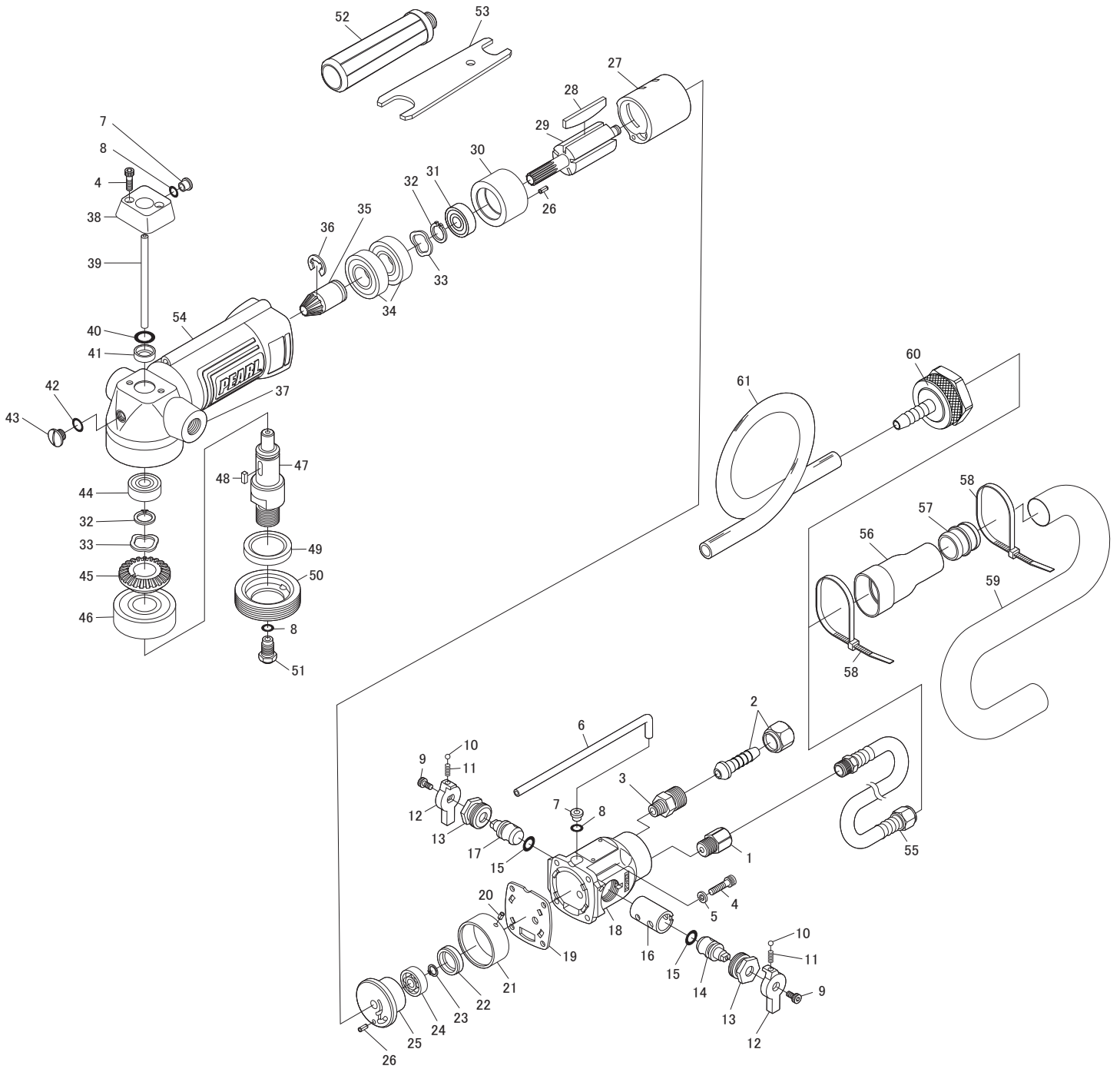

	<b>PART NAME</b>	<b>QTY.</b>	<b>PART NUMBER</b>
1	Inlet Bushing	1	670200
2	Hose Nipple	1	670201
3	Hose Adaptor	1	670202
4	Cap Screw	4	670203
5	Washer	4	670204
6	Outer Pipe	1	670205
7	Pipe Bush	2	670206
8	O-Ring	3	670207
9	Cap Screw	2	670208
10	Steel Ball	2	670209
11	Spring	2	670210
12	Lever	2	670211
13	Valve Nut	2	670212
14	Air Valve	1	670213
15	O-Ring	2	670214
16	Valve Bush	1	670215
17	Water Valve	1	670216
18	Valve Housing	1	670217
19	Gasket	1	670218
20	Roll Pin(2.5ø-4mm)	1	670219
21	Rear Case	1	670220
22	Bearing Cap	1	670221
23	Retaining Ring	1	670222
24	Ball Bearing	1	670223
25	Rear Plate	1	670224
26	Roll Pin(2.5ø-5mm)	2	670225
27	Cylinder	1	670226
28	Rotor Blade	5	670227
29	Rotor	1	670228
30	Front Plate	1	670229
31	Ball Bearing	1	670230

	<b>PART NAME</b>	<b>QTY.</b>	<b>PART NUMBER</b>
32	Retaining Ring	2	670231
33	Wave Washer	2	670232
34	Ball Bearing	2	670233
35	Pinion Gear	1	670234
36	Retaining Ring	1	670235
37	Motor Housing	1	670236
38	Pipe Connector	1	670237
39	Inner Pipe	1	670238
40	O-Ring	1	670239
41	Oil Seal	1	670240
42	O-Ring	1	670241
43	Grease Plug	1	670242
44	Ball Bearing	1	670243
45	Bevel Gear	1	670244
46	Ball Bearing	1	670245
47	Spindle(5/8")	1	670246
48	Key	1	670247
49	Oil Seal	1	670248
50	Spindle Cap	1	670249
51	Nozzle	1	670250
52	Handle	1	670251
53	Spanner Wrench (14 x 19mm)	1	670252
54	Housing Cover	1	670253
55	Wipe Hose Black	1	670254
56	Exhaust Cover A	1	670255
57	Connector	1	670256
58	Harness Band	2	670257
59	Exhaust Hose	1	670258
60	Water Hose Joint	1	670259
61	Water Hose Black	1	670260

## xii. HOW TO ORDER PARTS

Please have the following information ready before calling:

**Model Number** and **Part Description**

For warranty purpose, please have the following ready: **Serial Number** and **When purchased and where**

All parts listed may be ordered from your Local warehouses. If the part is not stocked locally, call our Corporate office and ask for our Customer Service Department. For Technical Support call **1-800-969-5561**. In Canada, call **1-800-387-0008**. There is a \$25.00 minimum order.

Return Policy: Return goods for credit or exchange on the basis of the following terms: **(1)** They must be current products; **(2)** Items returned for replacement or refund should be in original cartons and must be accompanied by a packing slip with the following information: Returned Goods Authorization (RGA) number obtainable from Customer Service Department • List of items

returned • Reason(s) for return(s) • Copy of original invoice(s); **(3)** Freight charges must be assumed by sender; **(4)** Returning goods are subject to a 15% handling charge to cover our cost of repacking and restocking. All Prices are subject to change without notice.

Disclaimer: Pearl Abrasive Co. reserves the right to make changes or improvements on its products without incurring an additional obligation including any obligation to make corresponding changes or improvements to products previously manufactured or sold. Pearl reserves the right to discontinue products at any time without notice.

All illustrations displayed in this manual are the property of Pearl Abrasive Co. and shall not be duplicated or reproduced without the express written consent of Pearl Abrasive Co.

## xiii. CUSTOMER SERVICE

AFTER SALE SERVICE. All customer service (technical questions, re-order of parts, etc.) will be provided by our company. All spare parts for after sales service will be stocked and shipped from our warehouse. If requested, we may arrange for our sales representatives to hold a training class for product knowledge at dealer's location.

## PEARL LIMITED WARRANTY

Every PEARL ABRASIVE CO. tool is thoroughly inspected and tested before leaving the factory. It is warranted to be free of defects in materials and workmanship for a period of 90 DAYS from the date of original purchase. Pearl will repair or (at our opinion) replace a product, or part thereof, found by PEARL ABRASIVE CO. to be defective, provided the defective product is returned to PEARL ABRASIVE CO., freight pre-paid, with proof of purchase.

**RGA NUMBER IS REQUIRED.** Prior to the return of any product or part, a Return Goods Authorization number must be obtained from PEARL ABRASIVE CO. by fax (562) 928-3857 or calling (800) 969-5561. The owner's name, address, phone number, as well as the serial number of the product, proof of purchase, and a brief statement detailing the nature of the claimed defect, are required for authorization.

**This Warranty does not apply where:**

- repairs have been made or attempted by others
- repairs are required because of normal wear and tear
- the tool has been abused, misused or improperly maintained
- alterations have been made to the tool
- the product is used in a manner or with a blade not recommended by the manufacturer

**In no event shall Pearl Abrasive Co. be liable for any indirect, incidental or consequential damages from the sale or use of the equipment. This disclaimer applies both during and after the term of warranty.**

**Pearl Abrasive Co. disclaims liability for any implied warranties, including implied warranties of "merchantability" and "fitness for a specific purpose", after the one year term of this warranty.**

This warranty gives you specific legal rights, and you may also have other rights which vary from state to state. Some states do not allow the exclusion or limitation of incidental or consequential damages, so the above limitation or exclusion may not apply to you. Some states do not allow limitation on how long an implied warranty lasts, so the above limitation may not apply to you.

All parts replaced under warranty will be considered as part of the original product and any warranty on these parts will expire coincidentally with the original product warranty.

This warranty supersedes all previous PEARL ABRASIVE product warranties. **EXCLUSION:** Water pump and motor warranty is through the original equipment manufacturer.

# PEARL®

**CORPORATE OFFICE: SO. CALIFORNIA • USA**

4900 ZAMBRANO ST., COMMERCE, CA 90040

FAX 562-927-5561 / 562-928-3857

PHONE 800-969-5561

[www.pearlabrasive.com](http://www.pearlabrasive.com)

**GEORGIA • USA**

3950 STEVE REYNOLDS BLVD.,  
NORCROSS GA 30093

**ONTARIO • CANADA**

375-2 PIDO ROAD  
PETERBOROUGH, ONTARIO K9J-6X7