

PEARL®

GrinderCaddy®

MODEL PA79GC

OWNER'S/OPERATOR'S MANUAL



Shown with
grinder and wheel

SERIAL NUMBER -

*You should record the Serial Number on this
Owner's/Operator's Manual.*

Caution! Read Safety and General Instructions carefully before using for the first time.

⚠ WARNING: This product can potentially expose you to chemicals that are known to the State of California to cause cancer and birth defects or other reproductive harm. For more information, go to: www.P65Warnings.ca.gov

REV. 2

PEARL ABRASIVE CO. - GRINDERCADDY®

TABLE OF CONTENTS

INTRODUCTION	3
<i>Key Terms</i>	3
<i>Disclaimer</i>	3
PRODUCT INFORMATION	3
<i>Safety Information</i>	3
<i>Warranty</i>	4
<i>Product Features</i>	4
INSTRUCTIONS FOR USE	5
PARTS BREAKDOWN	9
SALES AND REPAIRS	10
<i>Customer Service</i>	10
<i>How to Order Parts</i>	10

INTRODUCTION

This manual is designed to provide the user with the information required to operate and maintain the GrinderCaddy® correctly and safely.



CAREFULLY READ AND FOLLOW ALL INSTRUCTIONS PROVIDED BY THE GRINDERCADDY® MANUFACTURER.

KEY TERMS



1. READ CAREFULLY:

Refers to important information that should be paid careful attention.



2. CAUTION:

Indicates a situation that may cause injury or damage to the machine if the user does not follow the instructions.



3. WARNING:

Indicates a situation that may cause injury or death if the user does not follow the instructions correctly.



4. DANGER:

Indicates a situation that will cause injury or death if the user does not follow the instructions as written.



5. PROHIBITED:

Identifies actions that should never be carried out by anyone interacting with the machine.

DISCLAIMER

PEARL®, and its affiliates, takes no responsibility for any damage, injury or death resulting from the incorrect or unsafe use of this machine. Use of this machine should be undertaken by competent persons only. It is the operators' responsibility to ensure that the following safety procedures are followed.

PRODUCT INFORMATION

Throughout this document there are several safety warnings. The user should read through this complete document before using the GrinderCaddy®.

SAFETY INFORMATION



1. READ CAREFULLY:

Ensure you read all information contained in this manual before using the GrinderCaddy®.



2. READ CAREFULLY:

Ensure you read the manual and safety instructions for the grinder and other components that are part of this unit.



3. DANGER:

Always wear the recommended personal protective equipment.



4. PROHIBITED:

Never expose the machine to moisture or rain.

There is a safety and information panel provided on the front of the GrinderCaddy® to alert the user of potential safety risks/hazards. Please read and adhere to all instructions on the Unit.

WARRANTY

1. PEARL® provides a Limited One-Year Warranty that applies to GrinderCaddy® only (this excludes the grinder and any other attachments and consumables).
2. Warranty does not cover wear and tear, breakage, misuse or theft. Warranty coverage is at the manufacturer's discretion.
3. Any unauthorized repair or part replacement will void warranty. Refer to manufacturer for all repairs.
4. Regular service must be carried out by competent persons only; failure to comply will void warranty.
5. Grinder (where purchased) is to be covered by original manufacturer. See appendix.
6. Warranty does not cover consumables. Warranty does not cover attachments.

PRODUCT FEATURES



INSTRUCTIONS FOR USE

Tools required:

- 16mm & 19mm Sockets
- 3, 5 & 6mm Allen
- 10mm Wrench



DO NOT OPERATE WITHOUT WEARING THE APPROPRIATE PERSONAL PROTECTIVE EQUIPMENT AND ASSESSING THE SURROUNDING AREA FOR HAZARDS.

STEP 1

Remove all wrapping and cut cable ties to lay out all parts: Frame (A), Handles (B) and Grinder Assembly (C).

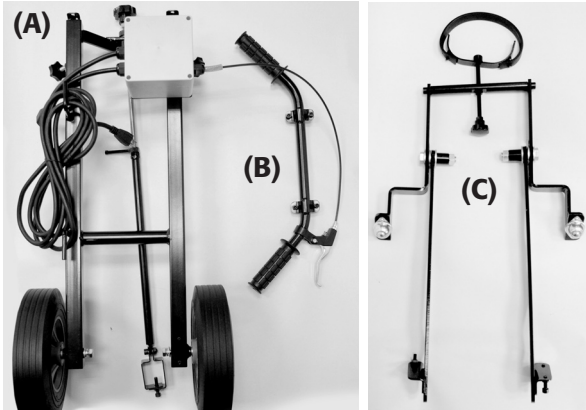

STEP 2

First, locate the handlebar assembly and remove the nuts from all 4 screws. Use 5mm Allen wrench.

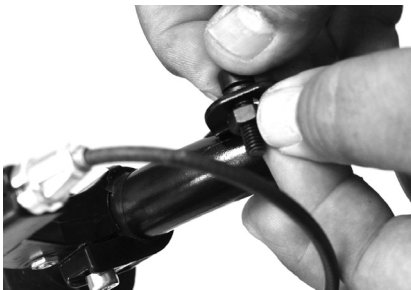

STEP 3

Align and insert the bolts through holes on the upper part of the frame. Attach washer and nuts then tighten to secure the handles. Use 5mm Allen wrench and 10mm wrench.



STEP 4

Locate the grinder assembly and remove just the nuts on both sides.



STEP 5

Insert the grinder in-between the bracket and insert the bolts into the grinder handle threads. The depth stop bracket has 4 holes and can be adjusted to new hole depending on size wheel or stone being used. Use 19mm socket wrench.

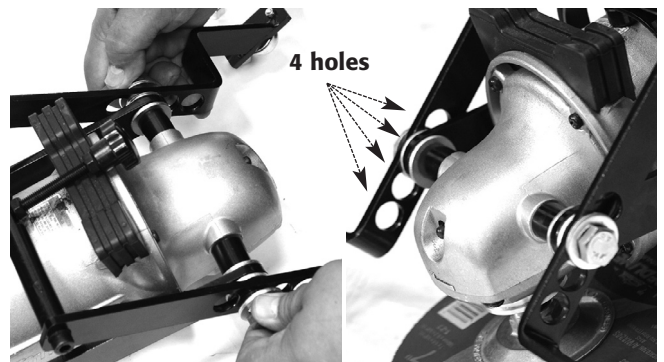

STEP 6

Lift the depth-stop bracket up, may need to loosen knob.



INSTRUCTIONS FOR USE (cont.)

STEP 7

Take the strap and wrap it around the grinder securing it to the other side.

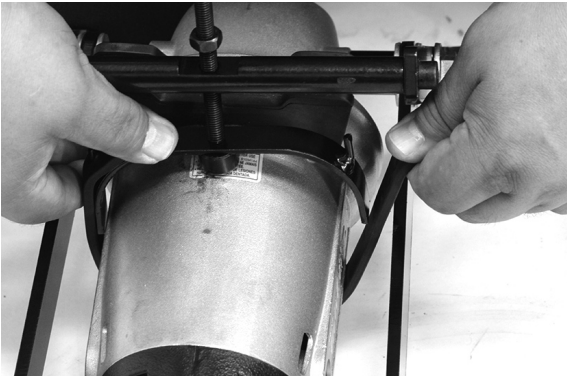

STEP 8

Must be secure but not too tight, there are multiple holes on the strap.

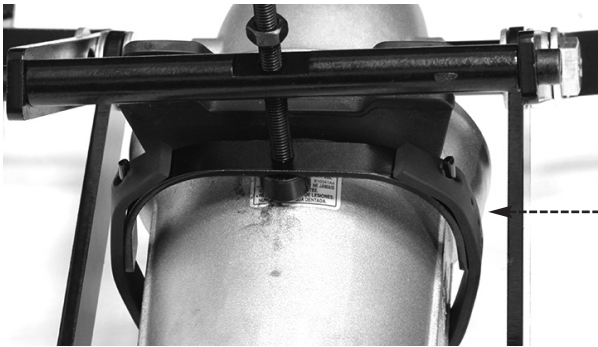

STEP 9

Locate the angle adjustment bracket and loosen bolt allowing it to come apart. Use 6mm Allen wrench and 13mm wrench.

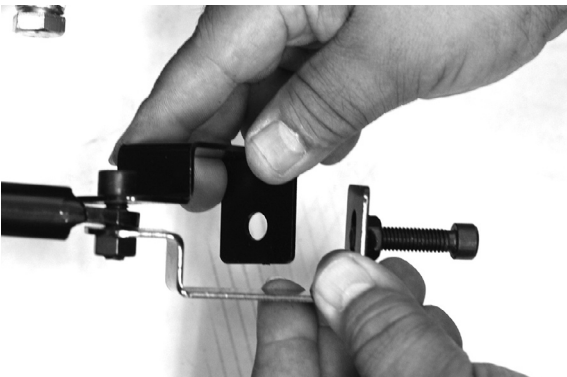

STEP 10

Secure angle adjustment bracket around the grinder handle and trigger area making sure the bolt is activating the trigger (bolt must keep trigger in the "ON" position at all times). Use 6mm Allen wrench.

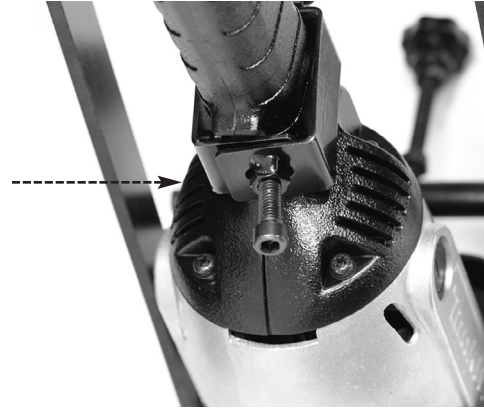

STEP 11

Remove bolts on the bottom frame assembly. Use 16mm socket wrench.



STEP 12

Remove the single bolt on the grinder assembly (one side will have 2 bolts on the other side will have one).



INSTRUCTIONS FOR USE (cont.)

STEP 13

Loosen the two bolts on the grinder assembly (do not need to remove only loosen). Use 5mm Allen wrench.



STEP 14

Attach bolts on bottom frame assembly through the grinder assembly and tighten. Use 16mm socket wrench.



STEP 15

Insert single bolt on the grinder assembly through the frame and attach nut in interframe. Use 5mm Allen wrench.

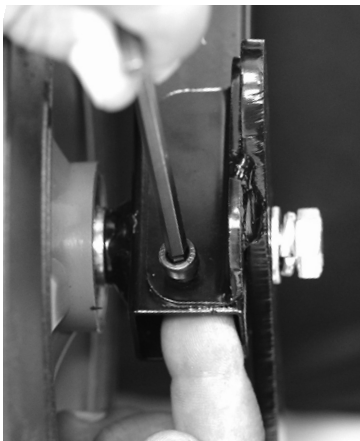

STEP 16

Tighten the two bolts on the grinder assembly and use the nuts to lock in place. Use 5mm Allen wrench



STEP 17

Check to make sure lock collars are tight but make sure they allow handle to spin freely. Use 3mm Allen wrench.

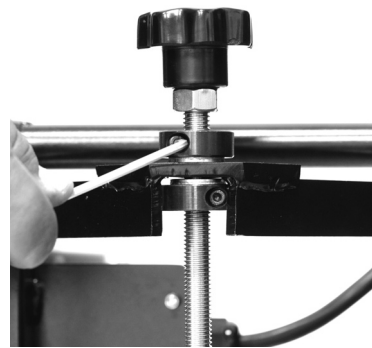

STEP 18

Plug in the grinder to the outlet on the switch box, wrap the extra cord around the holder.

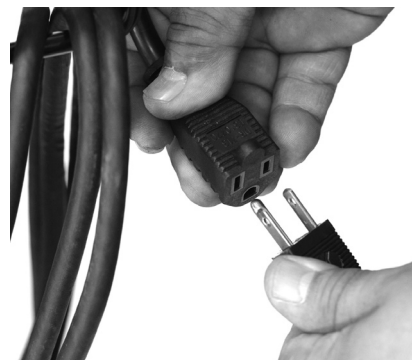

INSTRUCTIONS FOR USE (cont.)

STEP 19

Loosen knobs on both sides of the frame to adjust handle height.

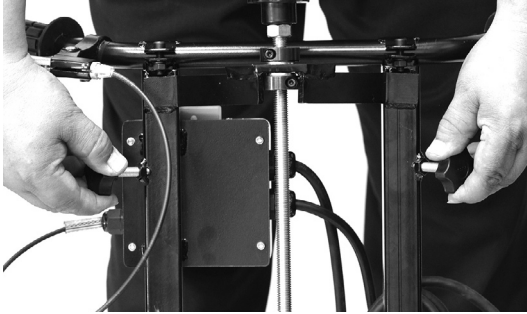

STEP 20

Pull handles out to the desired height and retighten knobs.

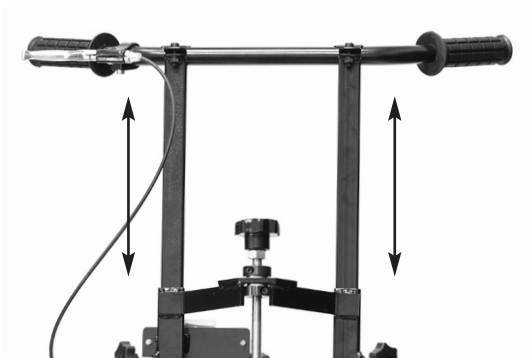

STEP 21

To adjust grinder angle, loosen the bolt holder and adjust the knob to the desired angle then retighten bolt holder to keep from moving.

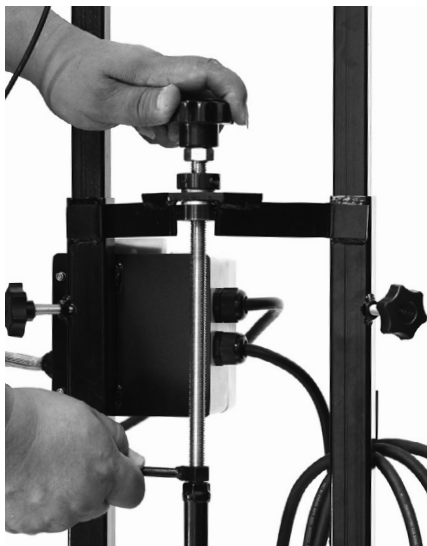

STEP 22

Adjust depth stop by putting the cart on an area adjacent to the material been grinded and adjust the knob to the height desired. The depth stop bracket has 4 holes and can be adjusted to new hole depending on size wheel or stone being used.

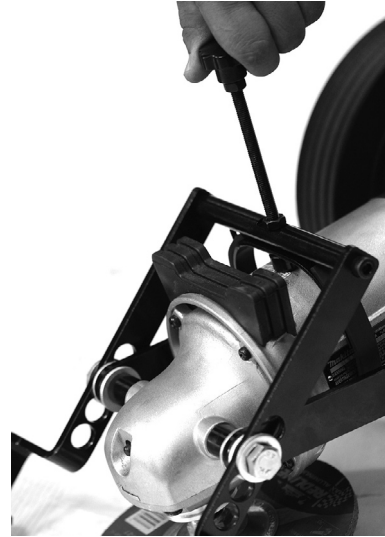

STEP 23

The cart has a 2-switch system, you will need to turn on/off switch on the box first.



STEP 24

Now to activate grinder, pull the lever on the handle.

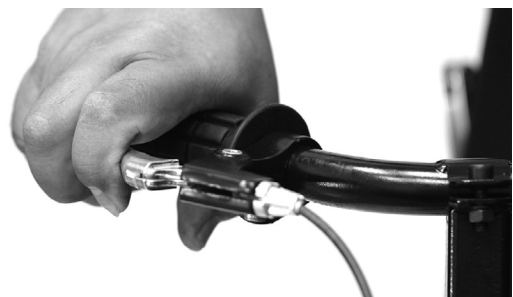

PARTS BREAKDOWN

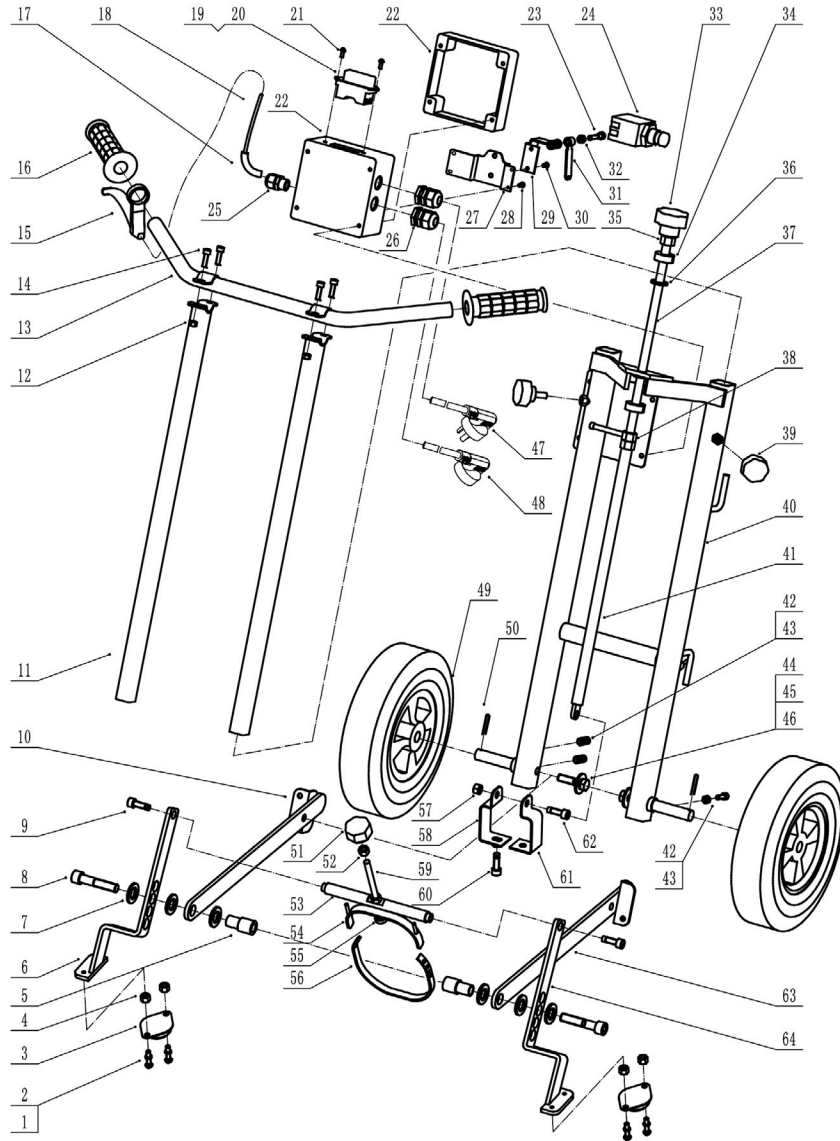

PART NAME	PART NUMBER
1 Bolt M4-12	4 GC0001
2 Spring washer	4 GC0002
3 Universal wheel	2 GC0003
4 Nut M4	4 GC0004
5 Front axle bushing	2 GC0005
6 Bending plate-Right	1 GC0006
7 Washer	6 GC0007
8 Bolt M12-1.75 x 65	2 GC0008
9 Bolt M8-20	2 GC0009
10 Connecting plate-Right	1 GC0010
11 Internal column	2 GC0011
12 Nut M6	4 GC0012
13 Handlebar	1 GC0013
14 Bolt M6-20	4 GC0014
15 Brake handle	1 GC0015
16 Handlebar grip	2 GC0016
17 Flexible conduit	1 GC0017
18 Brake cable	1 GC0018
19 Power switch	1 GC0019
20 Switch cover	1 GC0020
21 Bolt M4-10	2 GC0021
22 Switch box	1 GC0022

PART NAME	PART NUMBER
23 Bolt M6-35	1 GC0023
24 Push switch	1 GC0024
25 Screw adapter	1 GC0025
26 Screw adapter	2 GC0026
27 Support plate	1 GC0027
28 Bolt	4 GC0028
29 Switch support	1 GC0029
30 Bolt M4-10	2 GC0030
31 Strut bar	1 GC0031
32 Nut M8	1 GC0032
33 Adjustable hand wheel	1 GC0033
34 Threaded fixing ring	2 GC0034
35 Nut M12	1 GC0035
36 Washer	2 GC0036
37 Bolt M12-380	1 GC0037
38 Adjust nut	1 GC0038
39 Plastic nut	2 GC0039
40 Outer support	1 GC0040
41 Standpipe	1 GC0041
42 Bolt M6-20	3 GC0042
43 Nut M6	3 GC0043
44 Bolt M10-25	2 GC0044

PART NAME	PART NUMBER
45 Washer	2 GC0045
46 Spring washer	2 GC0046
47 Power cord	1 GC0047
48 Plug base	1 GC0048
49 Back wheel	2 GC0049
50 Splitpin	2 GC0050
51 Adjustable hand wheel	1 GC0051
52 Nut M8	2 GC0052
53 Bending plate connection shaft	1 GC0053
54 Front support plate	1 GC0054
55 Locking head	1 GC0055
56 Rubber strip	1 GC0056
57 Nut M8	1 GC0057
58 Fixed plate I	1 GC0058
59 Bolt M8	1 GC0059
60 Bolt M8-35	1 GC0060
61 Fixed plate II	1 GC0061
62 Bolt M8-20	1 GC0062
63 Connecting plate-Left	1 GC0063
64 Bending plate-Left	1 GC0064

SALES AND REPAIRS

For sales and spare parts please see below.

CUSTOMER SERVICE

AFTER SALE SERVICE

All customer service (technical questions, re-order of parts, etc.) will be provided by our company. All spare parts for after sales service will be stocked and shipped from our warehouse. If requested, we may arrange for our sales representatives to hold a training class for product knowledge at dealer's location.

HOW TO ORDER PARTS

Please have the following information ready before calling:

- **Serial Number**
- **Model Number**
- **When purchased and where**
- **Part Description**

All parts listed may be ordered from your Local warehouses. If the part is not stocked locally, call our Corporate office and ask for our Customer Service Department. For Technical Support call **1-800-969-5561**. There is a \$25.00 minimum order.

Return Policy: Return goods for credit or exchange on the basis of the following terms: **(1)** They must be current products; **(2)** Items returned for replacement or refund should be in original cartons and must be accompanied by a packing slip with the following information: Returned Goods Authorization (RGA) number obtainable from Customer Service Department • List of items returned • Reason(s) for return(s) • Copy of original invoice(s); **(3)** Freight charges must be assumed by sender; **(4)** Returning goods are subject to a 15% handling charge to cover our cost of repacking and restocking. All Prices are subject to change without notice.

Disclaimer: Pearl Abrasive Co. reserves the right to make changes or improvements on its products without incurring an additional obligation including any obligation to make corresponding changes or improvements to products previously manufactured or sold. Pearl reserves the right to discontinue products at any time without notice.

All illustrations displayed in this manual are the property of Pearl Abrasive Co. and shall not be duplicated or reproduced without the express written consent of Pearl Abrasive Co.

ANGLE GRINDER MANUAL

Angle grinder manual will be provided with grinder purchase.

GrinderCaddy®

PEARL®

CORPORATE OFFICE: SO. CALIFORNIA • USA
4900 ZAMBRANO ST., COMMERCE, CA 90040-0031
562-927-5561 • FAX 562-928-3857
Toll Free: 800-969-5561
www.pearlabrasive.com

GEORGIA • USA
3950 STEVE REYNOLDS BLVD.,
NORCROSS, GEORGIA 30093

ONTARIO • CANADA
375-2 PIDO ROAD
PETERBOROUGH, ONTARIO K9J-6X7